

acer



Acer Chromebook 714

USER'S MANUAL

© 2019. All Rights Reserved.

Acer Chromebook 714

Covers: CB714-1W

This revision: March 2019

Sign up for an Acer ID and enjoy great benefits

1. Ensure you are connected to the Internet.
2. Open **www.acer.com** and select your country.
3. Select **Support > REGISTER A PRODUCT**.
4. Sign up for an Acer ID or sign in if you already have an Acer ID.

Register your Acer product

After we receive your product registration, you will be sent a confirmation email with important data. Keep this email in a safe place.

Manage your registered products

Once you have completed the registration process, you can log onto **account.acer.com** using your Acer ID and password to see and manage all your registered products.



Note

It may take a few days for your information to be updated to the database.



Important

This manual contains proprietary information that is protected by copyright laws. The information contained in this manual is subject to change without notice. Images provided herein are for reference only and may contain information or features that do not apply to your computer. Acer Group shall not be liable for technical or editorial errors or omissions contained in this manual.

Model number: _____

Serial number: _____

Date of purchase: _____

Place of purchase: _____

TABLE OF CONTENTS

| | | | |
|---|-----------|--|-----------|
| Getting started | 4 | Playing video or audio files | 20 |
| Turn on your Chromebook | 4 | Other Supported File Types..... | 20 |
| Select your language settings | 4 | Chrome OS tips and tricks | 21 |
| Connect to a network..... | 4 | Documents..... | 21 |
| Accept the Terms of Service..... | 4 | How to create documents | 21 |
| First-time sign-in | 4 | Finding your documents..... | 22 |
| Create a new Google™ Account | 4 | How to share documents with other | |
| Browse as a guest | 4 | users | 22 |
| Sign in to your Google Account | 5 | How to start a video chat | 22 |
| Your Acer Chromebook tour | 6 | How to listen to music..... | 23 |
| Front view | 6 | How to watch videos, TV, or movies..... | 23 |
| Keyboard view | 7 | Working with Microsoft Office (Word, | |
| Function keys..... | 7 | Excel, and Powerpoint) documents | 24 |
| Common keyboard shortcuts | 8 | Open and edit Microsoft Office files using | |
| Touchpad | 9 | Google's office compatibility mode | 24 |
| Left view | 10 | Convert Microsoft Office files to Google | |
| Right view | 11 | Drive formats..... | 24 |
| USB 3.1 Gen 1 information | 11 | Export Google Drive documents as | |
| USB Type-C information | 11 | Microsoft Office files..... | 24 |
| Bottom view | 12 | Opening Microsoft Office files using | |
| The Chrome OS Desktop | 13 | Microsoft's Office Online apps from the | |
| Window controls | 13 | Chrome Web Store or Google Play Store . | 25 |
| Shelf | 14 | How to use your Chromebook when | |
| Launcher | 14 | there's no internet..... | 25 |
| Pinned apps | 15 | Gmail Offline | 26 |
| Status area..... | 15 | Google Drive | 26 |
| Apps & extensions | 16 | Settings | 28 |
| Managing apps | 16 | Changing the language settings | 28 |
| Installing apps from Chrome Web Store .. | 16 | Changing the clock settings..... | 29 |
| Installing apps from Google Play Store | 17 | Customizing appearance | 29 |
| Removing apps from Chrome OS..... | 17 | Customizing the wallpaper..... | 29 |
| Google Drive | 17 | Customizing the theme | 29 |
| Difference between Drive and Files apps . | 18 | Setting up your fingerprint account..... | 30 |
| Creating a new document..... | 18 | Setting up a printer | 31 |
| Sync files from Downloads to Google | | Updating Chrome OS | 31 |
| Drive..... | 18 | Automatic update | 31 |
| Enable offline access to Google Drive | | Manual update | 31 |
| files..... | 19 | Resetting your Chromebook | 32 |
| Gmail | 19 | Help | 33 |
| Composing an email | 19 | Online and offline help..... | 33 |
| YouTube | 20 | | |

GETTING STARTED

Turn on your Chromebook

On the Chromebook, the power button is located at the top-right corner of the keyboard. A "Welcome" screen will appear when the Chromebook first boots up.

Select your language settings

Use the "Language" drop-down list to choose your default language setting. If there is more than one way to type in your language, you may be prompted to select a keyboard input method as well.

Connect to a network

Select a network from the "Connect to network" list to connect to the Internet. If network access is protected, you will need an access password to connect to it.

Accept the Terms of Service

Once connected to a network, accept the Terms of Service. Your Chromebook will then download any available system updates, so you automatically get the latest Chrome OS features.

First-time sign-in

Create a new Google™ Account

You can create a new Google Account if you don't already have one. Select **Create a Google Account** to set up a new account. A Google Account gives you access to useful web services developed by Google, such as Gmail, Google Drive, and Google Calendar.

Browse as a guest

You can also use the Chromebook without a Google Account by selecting **Browse as a Guest**.

Sign in to your Google Account

If you already have a Google Account, enter your username and password in the sign-in box that appears and select the **Sign in** button.

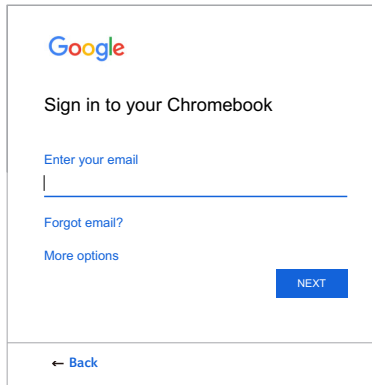

The screenshot shows the Google sign-in interface for a Chromebook. At the top is the Google logo. Below it is the text "Sign in to your Chromebook". There is a text input field with the placeholder "Enter your email" and a blue underline. Below the input field are two links: "Forgot email?" and "More options". A blue "NEXT" button is positioned to the right of the input field. At the bottom left, there is a "← Back" link.



Important

Sign in with your primary Google Account. This account will be set as the owner and is the only account that will be able to change certain Chrome settings.

YOUR ACER CHROMEBOOK TOUR

Now that you are done setting it up, let us show you around your new Acer Chromebook.

Front view

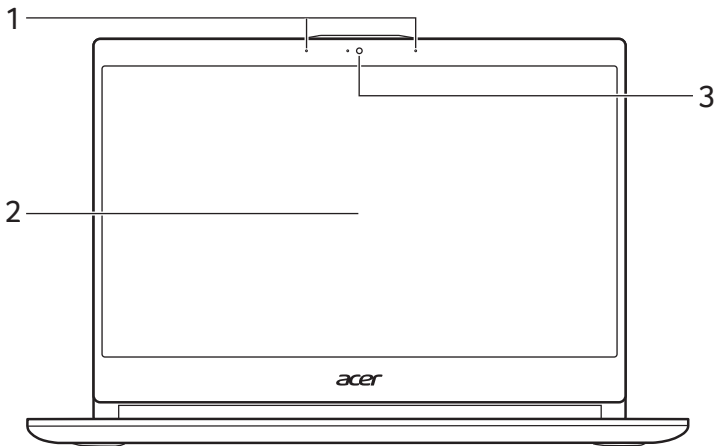

| # | Icon | Item | Description |
|---|------|-------------|---|
| 1 | | Microphones | Internal microphones for sound recording. |
| 2 | | Screen | Displays computer output. |
| 3 | | Webcam | Web camera for video communication. <i>A light next to the webcam indicates that the webcam is active.</i> |

Keyboard view

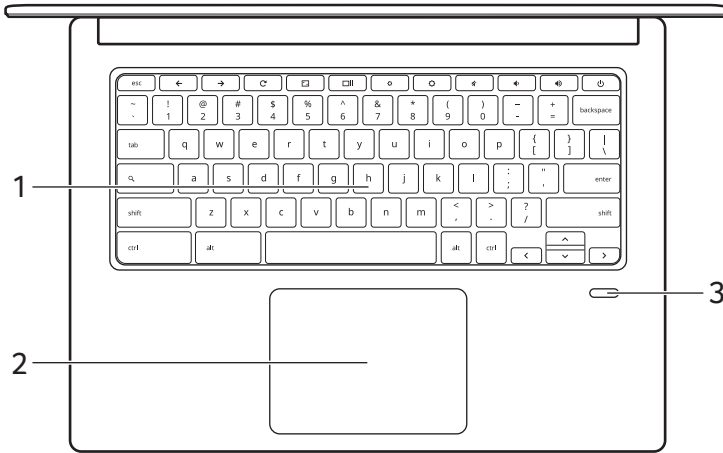











| # | Icon | Item | Description |
|---|------|-------------------------------|--|
| 1 | | Keyboard | For entering data into your computer. |
| 2 | | Touchpad / click button | <p>Touch-sensitive pointing device which functions like a computer mouse.</p> <p><i>Pressing down anywhere on the pad functions like the left button of a mouse.</i></p> <p><i>Pressing down anywhere with two fingers functions like the right button of a mouse.</i></p> |
| 3 | | Fingerprint reader (optional) | Fingerprint reader for unlocking your computer. |

Function keys





The computer uses function keys or key combinations to access some hardware and software controls, such as screen brightness and volume. The dedicated function keys each have a specific function.

| Icon | Function | Description |
|------|----------|--------------------------|
| ← | Previous | Go to the previous page. |

| Icon | Function | Description |
|---|-----------------|------------------------------------|
|  | Next | Go to the next page. |
|  | Reload | Reload the current page. |
|  | Full-screen | Open the page in full-screen mode. |
|  | Next window | Switch to the next window. |
|  | Brightness down | Decreases the screen brightness. |
|  | Brightness up | Increases the screen brightness. |
|  | Mute | Turns off audio output. |
|  | Volume down | Decreases the volume. |
|  | Volume up | Increases the volume. |
|  | Search | Search from the Apps panel. |

Common keyboard shortcuts

You can use shortcuts to complete some tasks more quickly.

| Keyboard shortcuts | Description |
|---|-----------------------------------|
| Ctrl +  | Takes screenshot. |
| Alt +  | Toggles caps lock. |
| Alt +  | Projects your screen. |
| Alt +  | Brightens the keyboard backlight. |
| Alt +  | Dims the keyboard backlight. |





Touchpad

The built-in touchpad is a pointing device that senses movement on its surface. This means the cursor responds as you move your fingers across the surface of the touchpad.

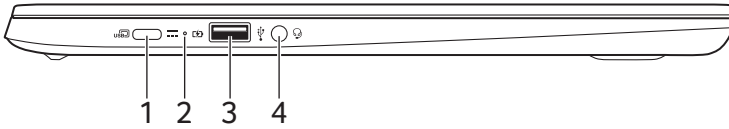
| Action | Gesture |
|-------------------------------|---|
| Click | Press down on any part of the touchpad. |
| Two-finger tap (or alt-click) | Tapping the touchpad with two fingers or pressing (and holding) Alt on the keyboard and tapping the touchpad with one finger both equal a "right-click" on a computer mouse. |
| Two-finger swipe | Place two fingers on the touchpad and move them up and down to scroll vertically, left and right to scroll horizontally. |
| Drag and drop | Select the item you want to move with one finger. With a second finger, move the item. Release both fingers to drop the item. (This gesture works for files, not windows or icons.) |



Left view

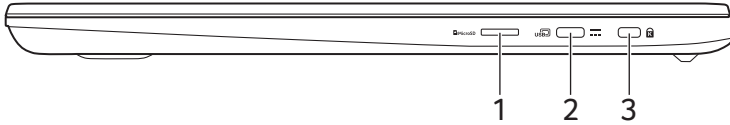

| # | Icon | Item | Description |
|---|---|----------------------------|---|
| 1 |  | USB Type-C port with DC-in | Connects to the provided USB Type-C power adapter and to USB devices with a USB Type-C connector. Supports DisplayPort™ over USB-C™. |
| 2 |  | Battery indicator | Indicates the computer's battery status. Charging: The light shows amber when the battery is charging. Fully charged: The light shows blue when in AC mode. |
| 3 |  | USB port | Connects to USB devices. |
| 4 |  | Headset / speaker jack | Connects to audio devices (e.g., speakers, headphones), or a headset with microphone. |

Right view



| # | Icon | Item | Description |
|---|---|----------------------------|--|
| 1 |  | MicroSD card slot | Insert a microSD card into this slot. |
| 2 |  | USB Type-C port with DC-in | Connects to the provided USB Type-C power adapter and to USB devices with a USB Type-C connector. Supports DisplayPort™ over USB-C™. |
| 3 |  | Kensington lock slot | Connects to a Kensington-compatible security lock. |

USB 3.1 Gen 1 information

- USB 3.1 Gen 1 compatible ports are blue.
- Compatible with USB 3.1 Gen 1 and earlier devices.
- For optimal performance, use USB 3.1 Gen 1-certified devices.
- Defined by the USB 3.1 Gen 1 specification (SuperSpeed USB).

USB Type-C information

- USB 3.1 Gen 1 with transfer speeds up to 5 Gbps.
- Supports DisplayPort™ audio/video output.
- Delivers up to 3 A at 5 V DC for USB charging.
- DC-in: requires power adapter or power source providing 45 W at 12/18~20 V.

For optimal performance, please use a certified Acer power adapter or USB Power Delivery device.

Bottom view

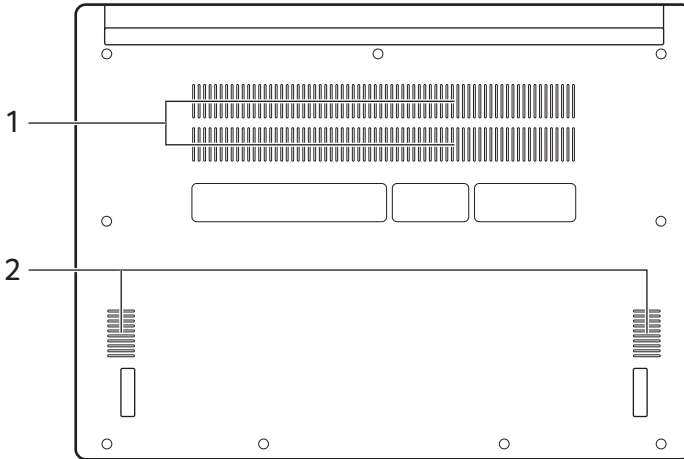

| # | Icon | Item | Description |
|---|------|-----------------------------|--|
| 1 | | Ventilation and cooling fan | Allows the computer to stay cool. <i>Do not cover or obstruct the openings.</i> |
| 2 | | Speakers | Deliver stereo audio output. |

THE CHROME OS DESKTOP

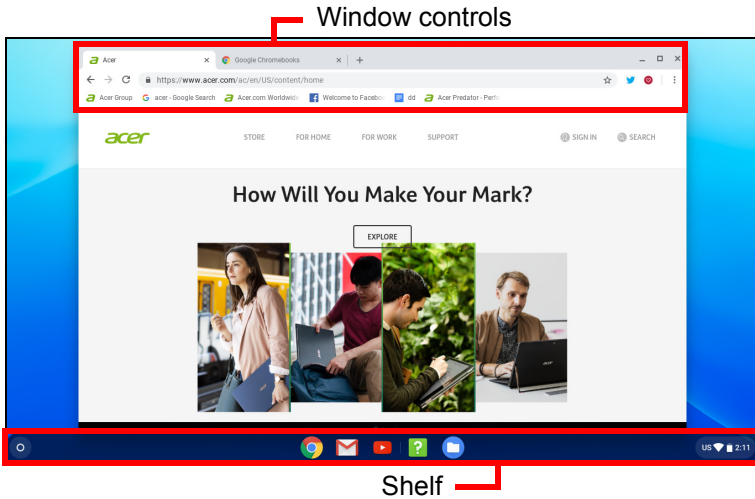

Window controls

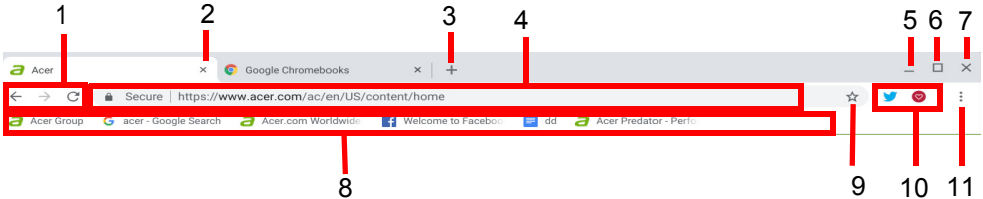

| Number | Description |
|--------|--|
| 1 | Goes <i>Backward</i> ← and <i>Forward</i> → in the current web browsing sessions's history (closing and reopening the Chrome browser begins a new session). Select to <i>Reload</i>  the current webpage. |
| 2 | Closes a tab. |
| 3 | Opens a new tab. |
| 4 | Type a web address or perform an internet search in this search box (also known as the "omnibox"). |
| 5 | Minimizes the window into the desktop shelf. |

| Number | Description |
|--------|--|
| 6 | Maximizes the window to take up the entire screen. Click again to return window to previous position. Also, select and hold to display a left ◀ and right ▶ arrow next to the icon. These neatly align the window to take up half the left side of the screen or the right side, respectively. |
| 7 | Closes the entire window (tabs and all). |
| 8 | Bookmark (save) webpage links to this quick-access area called the "bookmarks bar". |
| 9 | Select to bookmark (save) a link to the current webpage. |
| 10 | Select to use any enabled extensions you have installed in Chrome from this extension list. |
| 11 | Select to customize and control Google Chrome. |

Shelf



Note

Specifications vary. Some icons may not be applicable to your Chromebook.

Launcher

Select the **Launcher** icon to display the launcher page. This is the fastest way to search for something. Simply start typing to search the internet, your bookmarks, any files you have stored in your Google Drive, and items in the Web Store.

The Launcher page is also the place to access all your apps. Below the search box are your frequently-used apps. Simply select one to open it. To see all apps you have installed, select .

Pinned apps

You can pin or unpin apps on the shelf.

To pin an app to the shelf

1. Select the **Launcher** icon.
2. Click  to select **All Apps** (or type the name of the desired app).
3. Locate and two-finger tap the desired app icon.
4. Select **Pin to shelf**.











To reorder the apps on the shelf, just drag them around.

To unpin an app from the shelf

1. Locate and two-finger tap the desired app icon from the shelf.
2. Select **Unpin**.

Status area

The Status area enables you to see vital computer information at a glance, such as the time, Wi-Fi signal strength, and battery life. Tap the **Status** area to display a box with more options.

| Icon | Description | Icon | Description |
|---|--------------------|---|-----------------------------|
|  | Notifications |  | Shut down |
|  | Lock screen |  | Settings |
|  | Volume control |  | Wireless network connection |
|  | Bluetooth status |  | Battery status |
|  | Night light |  | Keyboard |
|  | Brightness control | | |

APPS & EXTENSIONS

You can enhance your Chromebook with extra web applications (Chrome apps, for short), features for the browser (also known as extensions) and apps designed for Android™ (Play Store apps). Chrome apps work like regular software programs for desktop computers, except they run entirely on the web. Extensions provide custom features and functionality for the Chrome browser. Android apps, designed for Android mobile devices are supported on Chromebooks. You can find Chrome apps and extensions through the Chrome Web Store, and Android apps using the Google Play Store.

Managing apps



Note

Certain apps and browser extensions may not be available in all countries and regions. The contents and design of the Web Store may vary by region. Updates may add new categories or change how to navigate the Web Store at any time.

Installing apps from Chrome Web Store

1. Select the **Launcher** icon.
2. Click  to select **All Apps** (or type "Web Store").
3. Select **Web Store**.
4. You can then browse through the app categories in the left column or search for a specific type of app using the search box.
5. When you find an app that you would like to add, select it and then select **Add to Chrome**.
6. A verification window will pop up, select **Add** to download and install the app, or select **Cancel**.

To open your new app, select the **Launcher**, then **All Apps** (or type the name of your new app), and then select the app.

Installing apps from Google Play Store

1. Select the **Launcher** icon.
2. Click  to select **All Apps** (or type "Play Store").
3. Select **Play Store**.
4. You can browse apps by category or search for an app by keyword.
5. Select an app to view more information.
6. Select **INSTALL** to download apps.

Downloaded apps will be installed in the **Launcher**. If you cannot find the apps, select **All Apps** from the **Launcher**.

Removing apps from Chrome OS

1. Select the **Launcher** icon.
2. Click  to select **All Apps** (or type the name of the desired app).
3. Two-finger tap on the app you want to remove. For more information [see Touchpad on page 9](#).
4. Select **Uninstall**.



Note

Some apps such as the Chrome web browser cannot be uninstalled.

Google Drive

All files saved to your *Google Drive* are saved online and are accessible to other devices, such as your smartphone or tablet. Files saved to the *Downloads* folder are saved to your local drive and are only accessible to your Chromebook.



Note

You must be connected to the Internet to do the following Google Drive operations.

Difference between Drive and Files apps

Google Drive is a web-based storage service offered by Google, and the *Files* app is the onboard storage system for your Chromebook. Because your Chromebook makes heavy use of the web, you can easily access files both from *Google Drive* and those that are stored locally by using the *Files* app on your Chromebook. To use the *Files* app, select the *Files* icon in the apps list, or use the keyboard shortcut <Alt> + <Shift> + <M>.

This user manual uses *Google Drive* and *Files* interchangeably when giving instructions regarding accessing files.

Creating a new document

1. From the Apps list, select the **Google Drive**  icon.
2. Select **New** and select the type of document you want to create.



Note

For an alternative method of creating documents, see [How to create documents on page 21](#).

Sync files from Downloads to Google Drive

1. Select the **Launcher** icon.
2. Click  to select **All Apps** (or type "Files").
3. Select the **Files** icon.

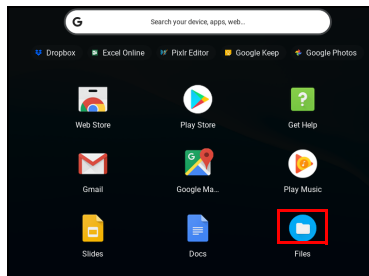

4. Select the files that you want to upload.

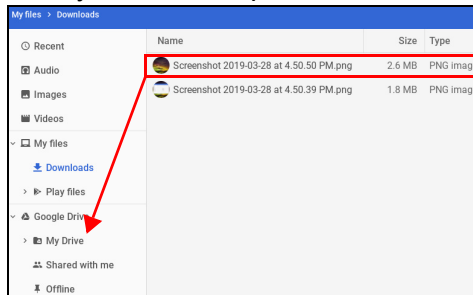

5. Drag-and-drop the files to *My Drive*.

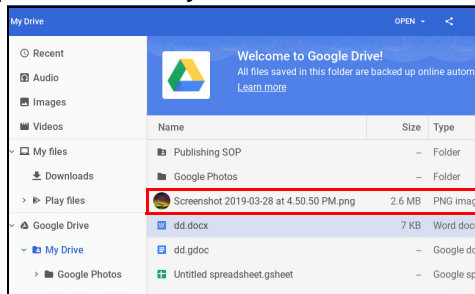

Enable offline access to Google Drive files

You can access files stored on your Google Drive while offline, but first you must enable offline access:

1. Select the **Launcher** icon.
2. Click  to select **All Apps** (or type "Files").
3. Select the **Files** icon and then select **My Drive**.
4. Select the file(s) you want to access offline.
5. Two-finger tap to bring up the context sensitive menu and select **Available offline**. For more information [see Touchpad on page 9](#).

Gmail

Composing an email

1. Select the **Launcher** icon.
2. Click  to select **All Apps** (or type "Gmail").

3. Select the **Gmail** icon and then **Compose**.
4. Enter the recipient's email address, the subject, and the message.
5. When you are finished composing your message, select **Send**.

YouTube

YouTube is a video-sharing website on which users can upload, share and view videos. You can access it by doing the following:

1. Select the **Launcher** icon.
2. Click  to select **All Apps** (or type "YouTube").
3. Select the **YouTube** icon.

Playing video or audio files

Your Chromebook has a built-in media player to play audio and video files. To play a file, double-click on an audio or video file in your *Files* app.

| Media type | Supported formats |
|---------------|---|
| Audio / Video | .3gp, .avi, .mov, .mp4, .m4v, .m4a, .mp3, .mkv, .ogv, .ogm, .ogg, .oga, .webm, .wav |

Other Supported File Types

Your Chromebook supports a number of other file formats.





| File type | Supported formats |
|------------------------|---|
| Microsoft Office files | .doc, .docx, .xls, .xlsx, .ppt (read-only), .pptx (read-only) |
| Images | .bmp, .gif, .jpg, .jpeg, .png, .webp |
| Compressed | .zip, .rar |
| Other | .txt, .pdf (read-only) |

CHROME OS TIPS AND TRICKS

Your Chromebook is a new type of computer that works somewhat differently than what you may be used to, so you might like to know how easy and useful things are when using it. Here are some tips and tricks.

Documents

How to create documents

1. Press the **Search**  key on your keyboard or select the **Launcher** icon.
2. Click  to select **All Apps** (or type "Google Docs", "Google Sheets", or "Google Slides" depending on the type of document you want to create) Create word processing files with *Google Docs*, spreadsheets with *Google Sheets*, and presentations with *Google Slides*.
3. Select **Google Docs** , **Google Sheets** , or **Google Slides** .

That's it. You've just created a new document in a few seconds. With your new document, you can add text, insert images, change the font, make it bold, underline it, italicize it – you get the gist. Most of the formatting and other stuff you might be familiar with from other productivity suites like Microsoft Office you can do with Google Docs.





Note

For an alternative method of creating documents, see [Creating a new document on page 18](#).

Finding your documents



All documents you create are saved to your *Google Drive* where they are online and accessible to other devices, such as your smartphone or tablet. To find your documents, do the following:

1. Select the **Launcher** icon.
2. Click  to select **All Apps** (or type "Google Drive").
3. Select the **Google Drive**  icon.
4. Select **My Drive** (or whatever sub-folder you've created to put your files in).

Since your files are saved in Google Drive, they are saved online and available anywhere you have internet access. To access your files from any internet-connected computer do the following:



1. Open the computer's web browser.
2. In the browser's address bar, type "drive.google.com" (this is the *Google Drive* web address).
3. Login using your Google account username and password.
4. Select **My Drive** (or whatever folder you've created to put your files in).

How to share documents with other users

1. Select **SHARE**  in the upper right corner of your document.
2. Add people by typing in their email address. The sharing option works with your Gmail contacts, so as you type your email contacts appear for you to quickly select.
3. After you select **Done** , they'll receive an email letting them know a document has been shared with them.



How to start a video chat

For all you Skype users out there, Google+ Hangouts are free video chats for up to ten people. To make a Hangouts video call, do the following:

1. Press the **Search**  key on your keyboard or select the **Launcher** icon.
2. Click  to select **All Apps** (or type "Hangouts").

3. Select the **Hangouts call**  icon.
4. Type in the name or email address of a person.
5. Select the **Invite** button to start your Hangouts.



How to listen to music

1. Press the **Search**  key on your keyboard or select the **Launcher** icon.
2. Click  to select **All Apps** (or type "Play Music").
3. Select **Play Music** .







Note

Play Music may not be available in all countries and regions. Google Play's current list of country availability for apps and digital content, visit <https://support.google.com/googleplay/answer/2843119?hl=en>

To listen to streaming music, you can download streaming apps like Pandora, Spotify, Rdio, Deezer and more (availability varies by country) from **Chrome™ Web Store**  or **Google Play Store** .



How to watch videos, TV, or movies

1. Press the **Search**  key on your keyboard or select the **Launcher** icon.
2. Click  to select **All Apps** and select one of the following options:
 - a. Select **YouTube**  to view a vast amount of user-uploaded videos covering nearly everything imaginable.
 - b. Select **Play Movies**  to watch the movies and TV shows you love.





Note

Play Movies may not be available in all countries and regions. Google Play's current list of country availability for apps and digital content, visit <https://support.google.com/googleplay/answer/2843119?hl=en>

- c. To find more entertainment apps like Netflix, Flixster, and more (availability varies by country), select **Web Store**  or **Play Store** . Then, search for "Netflix" or other entertainment apps.



Working with Microsoft Office (Word, Excel, and Powerpoint) documents

Open and edit Microsoft Office files using Google's office compatibility mode



1. Press the **Search**  key on your keyboard or select the **Launcher** icon.
2. Click  to select **All Apps** (or type "Files").
3. Select the **Files**  icon.
4. Double-click on any **Microsoft Office** file stored in Google Drive or on an external hard drive or USB flash drive connected to your Chromebook.

Google Chrome automatically opens and enables limited editing of the document.

Convert Microsoft Office files to Google Drive formats

1. Press the **Search**  key on your keyboard or select the **Launcher** icon.
2. Click  to select **All Apps** (or type "Files").
3. Select the **Files**  icon.
4. Double-click on any **Microsoft Office** file stored in Google Drive or on an external hard drive or USB flash drive connected to your Chromebook.
5. Select **File** > **Save as Google Docs, Slides, or Sheets** (format depends on the type of document).

Export Google Drive documents as Microsoft Office files

1. Press the **Search**  key on your keyboard or select the **Launcher** icon.
2. Click  to select **All Apps** (or type "Docs").
3. Select **Google Docs, Sheets, or Slides** (depending on the document you want to create).

4. After creating the content of your document, select **File > Download as** and select the type of format you want to save as.
5. The file is saved to the *download* section of the *Files* app.

Opening Microsoft Office files using Microsoft's Office Online apps from the Chrome Web Store or Google Play Store

Another option for working with Microsoft Office files is to use Microsoft's own free web-based Office Online tools. You can download the Word Online, Excel Online, and PowerPoint Online apps from the Chrome Web Store or Google Play Store (you'll need to create a Microsoft account if you don't already have one). Then, you can login and create files or upload files you have already created and edit them.



Note

*Office Online programs save files you create exclusively to Microsoft's own OneDrive cloud storage. Though you can download a file you create and then move it to Google Drive or a removable storage device, you cannot save it directly to those locations. Also, to work on a file you've already created, you must first upload it to OneDrive by selecting **Open from OneDrive** from within whichever Office Online product you are using (you can install the OneDrive app from the Web Store as well).*

How to use your Chromebook when there's no internet



The Chrome Web Store contains useful offline apps. For more information [see Installing apps from Chrome Web Store on page 16](#). You're able to filter your app search by selecting the **Runs Offline** checkbox. For those times you don't have an internet connection, these apps help you stay productive and entertained. A few of the pre-installed options are described below.

Gmail Offline



Note

*The first time you use Gmail Offline you **MUST** be connected to the internet to enable offline viewing.*





1. Press the **Search**  key on your keyboard or select the **Launcher** icon.
2. Click  to select **All Apps** (or type "Gmail Offline").
3. Select the **Gmail Offline**  icon.
4. Use the app like you normally would. It'll update and send your emails the next time you log on to the internet.

Google Drive



Important

Any changes you make to a current document or any document you create while offline are saved locally on your computer and will not be seen if you open the document from Google Drive on another computer or device. The changes will only be reflected in the Google Drive online version of the document the next time you connect to the internet and access Google Drive.

1. Press the **Search**  key on your keyboard or select the **Launcher** icon.
2. Click  to select **All Apps** (or type "Google Drive").
3. Select the **Google Drive**  icon.
4. Open a Google document you have already created or create one as you normally would. For more information **see [Creating a new document on page 18](#)**. Notice the offline  icon displays next to the file name reminding you that you are working on this document while not connected to the internet.

5. Make your desired changes. The next time you are online and have Google Drive open, your local changes will upload to Google Drive.



Note

If you make changes to a Google document while offline and someone else makes changes to the document as well (for example, if the document is shared with someone else), the next time you are online and have Google Drive open, your changes will merge with the other person's changes.

You can't open and access every type of file you have saved in Google Drive when there is no internet connection. To enable offline access to file types other than Google documents when offline, **see [Enable offline access to Google Drive files on page 19](#)**.

SETTINGS

Use the settings menu to adjust the various options for your Chromebook. To access the settings menu do the following:

1. Select the **Status** area of the shelf in the lower-right corner of the screen.
2. Select **Settings**  icon.

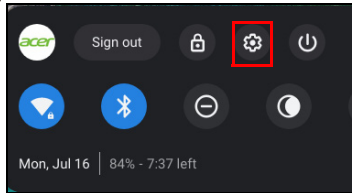

3. To show the advanced settings, scroll to the bottom and select **Advanced**.



Note

Using default settings, the Chromebook will enter hibernate mode after one hour.

Changing the language settings

1. Select the **Status** area of the shelf in the lower-right corner of the screen.
2. Select **Settings**  icon.
3. Select **Advanced**.
4. Scroll down and select **Language** in the *Languages and input* section.
5. Select **Add languages** to add additional languages.
6. To enable a language for keyboard input, under *Input Method* select the checkbox next to your desired input method.
7. Select **Add** when finished.

Changing the clock settings

You can change the time format and time zone on your Chromebook. If the date or time is incorrect on your Chromebook, try adjusting the time zone.

To change the time zone:

1. Select the **Status** area of the shelf in the lower-right corner of the screen.
2. Select **Settings**  icon.
3. Select **Advanced**.
4. In the *Date and time* section, select the desired time zone from the the drop down box.

Customizing appearance

Customizing the wallpaper

1. Select the **Status** area of the shelf in the lower-right corner of the screen.
2. Select **Settings**  icon.
3. In the *Appearance* section, select **Wallpaper**.
4. To pick your own wallpaper, select **My Images**. To pick Chrome wallpaper, you can browse through the categories in the left column and click an image.

You can also choose **Daily Refresh** to set your wallpaper to cycle through random order daily.

Customizing the theme

1. Select the **Status** area of the shelf in the lower-right corner of the screen.
2. Select **Settings**  icon.
3. In the *Appearance* section, select **Browser themes**.
4. You'll be taken to the *Chrome Web Store*, where you can find extra resources for the Chrome browser.

5. Once you find a theme that you'd like to try out, select it and then select **Add to Chrome**.

Setting up your fingerprint account



You can use the fingerprint reader to unlock your Chromebook. You'll have the option to register your fingerprint when you first set up your Chromebook. If you skip that step, set up your fingerprint anytime through your device settings. To set up your fingerprint, do the following:

1. Select the **Status** area of the shelf in the lower-right corner of the screen.
2. Select **Settings**  icon.
3. In the *People* section, select **Screen lock and sign-in**.
4. Enter your *Password* and select **Confirm**.
5. Next to *Edit Fingerprints*, select **Set up** then click **Add Fingerprint**. Follow the onscreen instructions to set up your fingerprint account.



Note



Locate the fingerprint sensor on your device, and then place the finger you would like to register. Press and hold your finger on the fingerprint sensor and then lift. Repeat this step until the fingerprint configuration is complete.

6. Click **Done** to complete the fingerprint configuration. You may select **Add Fingerprint** to add another fingerprint account and create up to three fingerprints per signed-in user.

Setting up a printer

You can use the *Google Cloud Print* service to send print requests to many types of traditional cabled printer and wireless "cloud ready" printers; however, not all printers are supported.

To learn more about *Google Cloud Print* and how to set up your printer, reference Google's own Chromebook Help to find comprehensive information on this topic. To access Chromebook Help, do the following:

1. Press the **Search**  key on your keyboard or select the **Launcher** icon.
2. Click  to select **All Apps** (or type "Get Help").
3. Select the **Get Help**  icon.
4. Select **Printing**.

Updating Chrome OS

Automatic update

Each time you turn on your Chromebook, it automatically checks for updates. When an update is available, this update icon  will appear as a notification in the status area. To apply the update:

1. Select the **Status** area of the shelf in the lower-right corner of the screen.
2. Select **RESTART TO UPDATE**.
3. Your Chromebook will shutdown and automatically restart, with the update applied.

Manual update

To manually check for an update or check what version of Chrome OS you are using:

1. Select the **Status** area of the shelf in the lower-right corner of the screen.
2. Select **Settings**  icon.
3. Select **About Chrome OS** from settings at the top left corner.

4. In the dialog that opens, select **Check for updates**. If any updates are available, they will be displayed on the page.



Important

Do not modify your Chromebook's hardware yourself. Doing so will cause the update function to no longer work. Please get in touch with your dealer or an authorized service center. Visit www.acer.com to find an authorized service site.

Resetting your Chromebook

There may be times when you want to reset your Chromebook (for example, removing your personal information and settings). Completely resetting your Chromebook is known as "Powerwashing", which is basically factory resetting your computer. After powerwashing, your Chromebook will look like it did out of the box (including all apps that came pre-installed). To powerwash your Chromebook, do the following:



Important

Powerwashing your Chromebook will remove all local settings, data, and programs from your hard drive. Backup any data on your hard drive that is not saved online by moving it to Google Drive and waiting for it to sync.

1. Select the **Status** area of the shelf in the lower-right corner of the screen.
2. Select **Settings**  icon.
3. Select **Advanced**.
4. In the *Reset settings* section, select **Powerwash**.
5. Select **Restart**.
6. In the box that appears, select **Powerwash > Continue**.

HELP

Online and offline help

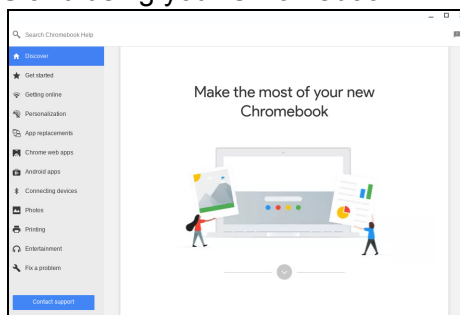

Additional help is available both online and offline. *Chromebook Help* is installed on your Chromebook and doesn't require internet access. It covers basic troubleshooting as well as more detailed information about Chrome OS and using your Chromebook.



Note

Some sections in Chromebook Help have web links, which require you to have internet access to view the additional information.

To access *Chromebook Help*, do the following:

1. Press the **Search**  key on your keyboard or select the **Launcher** icon.
2. Click  to select **All Apps** (or type "Get Help").
3. Select the **Get Help** .